

Talon and Talon SR User Manual

Brushed DC motor controller

Version 1.3



Cross the Road Electronics, LLC

www.crosstheroadelectronics.com

Device Overview

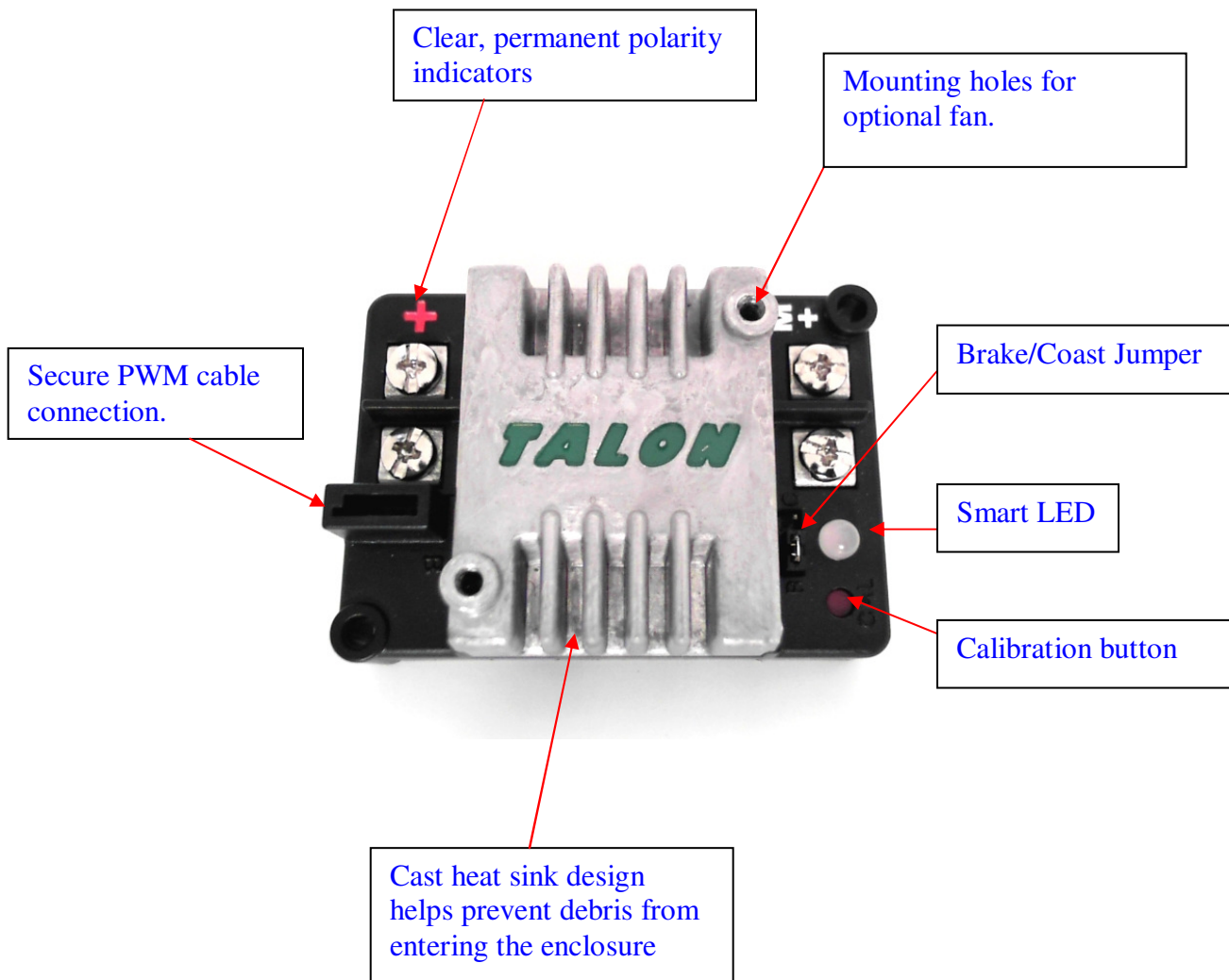

1) What is a Talon?

Both the Talon and Talon SR are devices used to control the rotational velocity (speed) of a brushed DC motor through modulating power over time. The differences between the Talon and Talon SR are indicated in **Orange** text throughout the manual.

2) Features

- Passive cooling design (heatsink)
- Conformal coating
- Locked-antiphase rectification (Talon)
- **Synchronous sign magnitude rectification (Talon SR)**
- Lightweight small foot print
- Smart LED, blinks proportional to throttle.
- 15 khz switching frequency
- Metal chip resistant
- 6-28 volt DC input
- Up to 100 amps peak 60 amps continuous current.
- Mounting holes to allow for optional 40 mm fan.
- Secure PWM connection
- Simple calibration
- 10-bit input and output precision
- User selectable brake/coast
- 4% neutral dead band
- Linear throttle response

3) Power

The Talon may be powered from any DC voltage source from 6 to 28 volts.



WARNING! The Talon does not have protection against reverse polarity. It is important that the user ensures that power has been connected in the correct polarity before powering the Talon. **If polarity is reversed, the Talon will be permanently damaged.** **ONLY** connect power to the input side of the device. Connecting unregulated power to the motor side of the device will damage the H-bridge.

The housing of the Talon has clear markings to indicate polarity. The red '+' sign indicates the positive power terminal. The white 'M+' indicates the positive motor terminal. See Figure 1 below.

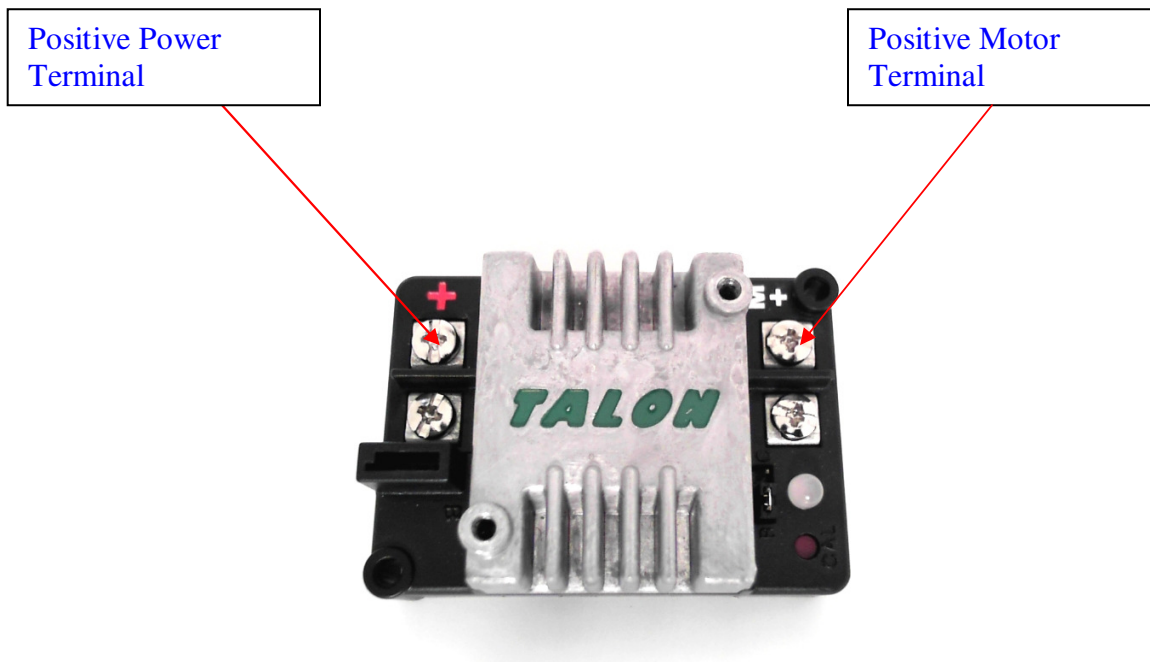

Figure 1

4) PWM Control Signal

The Talon requires a Pulse Width Modulated (PWM) input signal. This signal should be between 1-2.0 ms (milliseconds) in duration with a center (neutral) pulse of 1.5 ms. The PWM cable should be a standard hobby servo cable with a .100" pitch. Insert the cable into the housing with the black (or ground) terminal aligned with the letter 'B' on the housing. See Figure 2 below. **The Talon SR uses an external crystal to reduce input timing drift over temperature range of the device.**

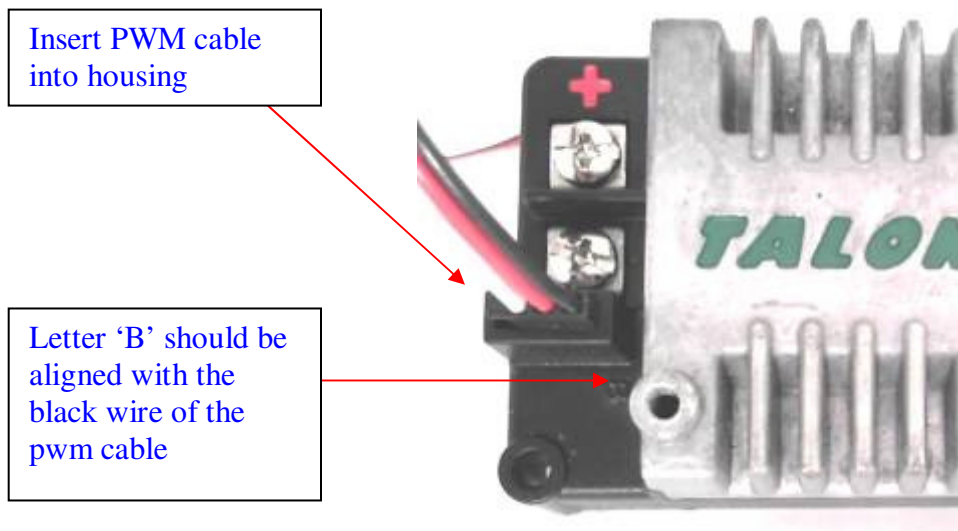

Figure 2

5) LED

The LED is used to indicate the direction and percentage of throttle and state of calibration. The LED may be one of three colors; red, orange or green. A solid green LED indicates positive output voltage equal to the input voltage of the Talon. A solid Red LED indicates an output voltage that is equal to the input voltage multiplied by -1 (input voltage = 12 volts, output equals -12 volts). The LED will blink its corresponding color for any throttle less than 100% (red indicates negative polarity, green indicates positive). The rate at which the led blinks is proportional to the percent throttle. The faster the LED blinks the closer the output is to 100% in either polarity. **The Talon SR has a more defined blink when transitioning between 100% throttle and 99%.**

The LED will blink orange any time the Talon is in the disabled state. This will happen if the PWM input signal is lost, or in FRC, when the robot is disabled. If the Talon is in the enabled state and the throttle is within the 4% dead band, the LED will remain solid orange.

Talon SR – The Talon SR has an additional LED state that blinks red/orange when a fault state is detected. A fault can be caused by one of three things; under voltage (< 3.3V DC), over temperature (>170 degrees C) or a shorted output transistor. During a fault the output of the Talon is disabled until the fault condition is no longer present.

6) Calibration

The calibration procedure takes the minimum, maximum and center values of the PWM input signal and scales the output based on these values. Calibrating the Talon will allow full range of control with PWM signals that are not within the default range. Calibrating will also correct any non-center issues with input devices such as gamepads or joysticks.

To calibrate the Talon:

1. Press and hold the button labeled "CAL" with a paper clip. The LED should begin to blink red/green.
2. Continue to keep the button pressed while moving the joystick full forward and full reverse. You may do this as many times as you like.
3. Center the joystick and then release the CAL button.
4. If calibration was successful, the LED will blink green several times. If the LED blinks red several times, the calibration was not valid. If this happens, the Talon will use the last valid calibration values.

All calibration values are retained after power cycle or reset.

7) Brake/Coast jumper

The Talon has a jumper that allows dynamic braking or coasting when the PWM input signal is within the 4% neutral dead band. If braking is desired, place the jumper between the center pin and the pin labeled 'B'. If coasting is desired place the jumper between the center pin and the pin labeled 'C'. See Figure 3 below. If the jumper is set to brake, the brake will remain on ANY time the talon is not outputting voltage, this includes the disabled state.

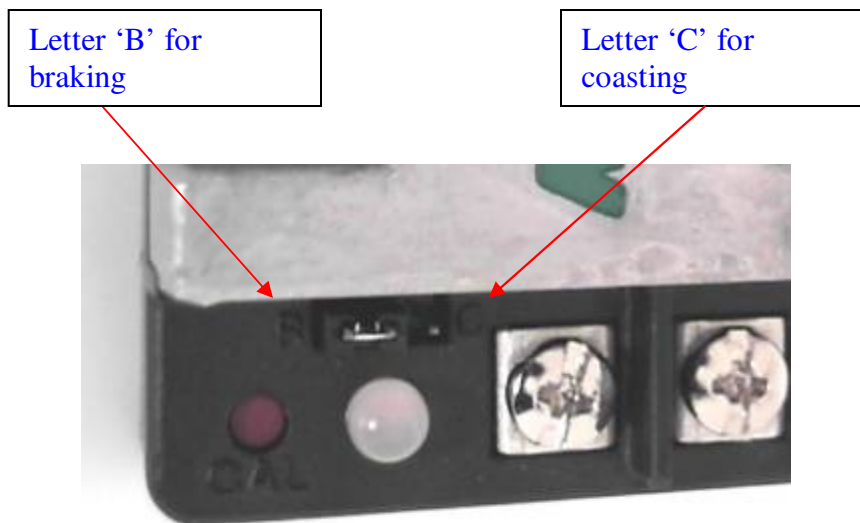

Figure 3

8) Optional Fan

The Talons heat sink has two bosses tapped to 6-32. These bosses may be used to install an optional 40 mm x 40 mm fan or to mount the Talon. The talon does not require a fan for operating currents of 30 amps or less. A fan of 4.7CFM or greater is recommended if the Talon will be subjected to loads that are continuously greater than 30 amps. Figures 5-7 show the relationship of current and temperature vs. time. These Figures should be used to determine if your application requires a fan. The average current may be used in determining if a fan is needed.

Fans are available at: www.crosstheroadelectronics.com



Figure 4 *Talon shown with optional fan.*

9) Mounting

The two mounting holes of the Talon are sized to allow screw sizes to 6-32. Screws should be hand tightened to prevent damage to the Talons case.



WARNING! Do not use anaerobic curing thread lockers such as Loctite 242 to secure screws used to mount the Talon. **Anaerobic curing thread lockers break down ABS plastic and will cause the Talon's case to crack.** If use of a thread locker is required, a cyanoacrylate based thread locker such as Loctite 425 should be used.

10) Test Configuration

All tests were performed using a test fixture consisting of two 2.5" CIM motors (part #PM25R-45F-1003), connected to an AndyMark CIMple box (part #AM-0734), connected in a master slave configuration (one motor back driving the other). The leads of the slave motor were open for the linearity test and shorted for all thermal testing. Throttle was used to obtain the desired load to the master motor.

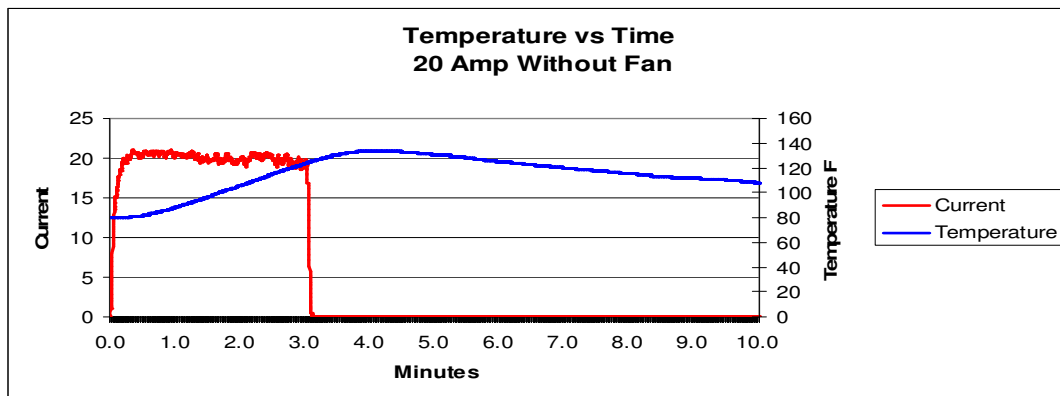

Figure 5

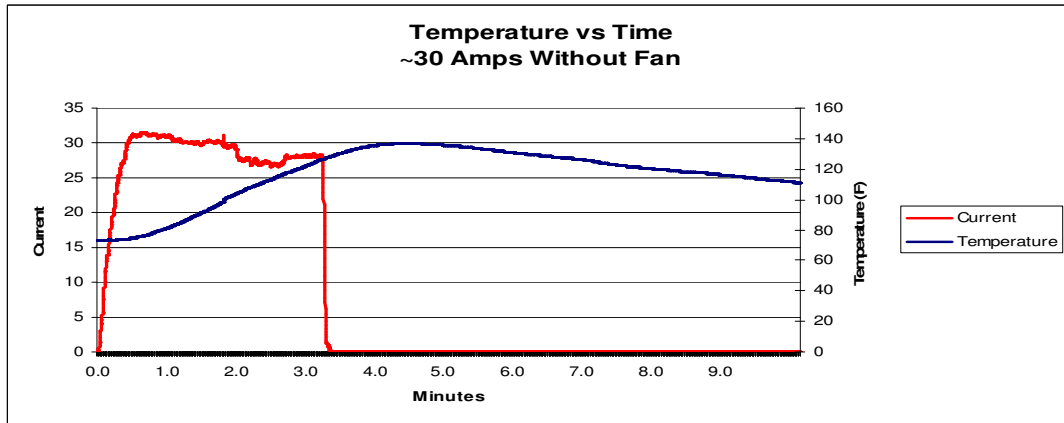

Figure 6

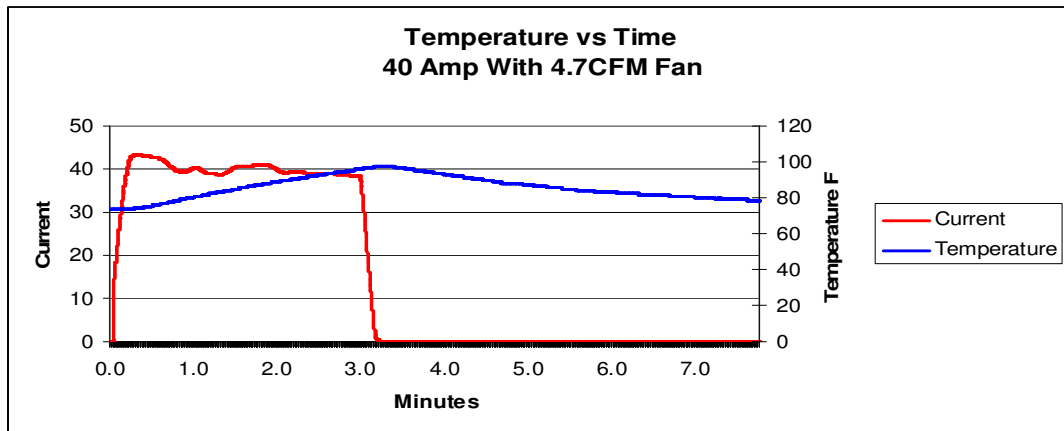

Figure 7 (test duration limited by motor temp)

11) Linearity

Figure 8 shows the relationship between RPM and Input throttle.

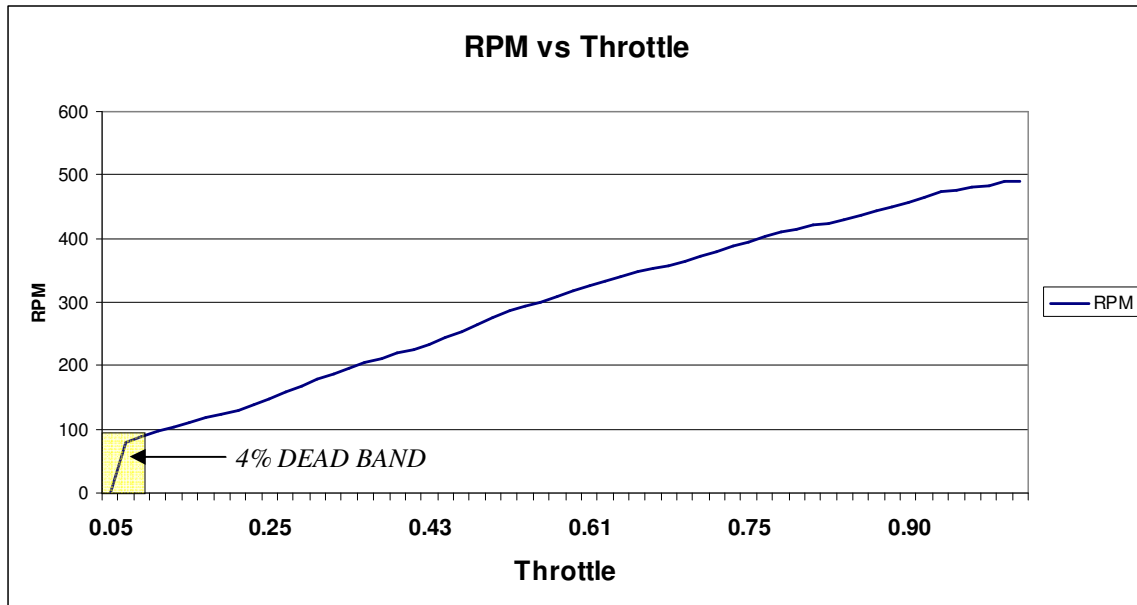

Figure 8 (slave motor leads open, apx. 6 amps)

12) Drawings

Figure 9 provides the dimensions ([mm]/inch) of the Talon to allow design integration.

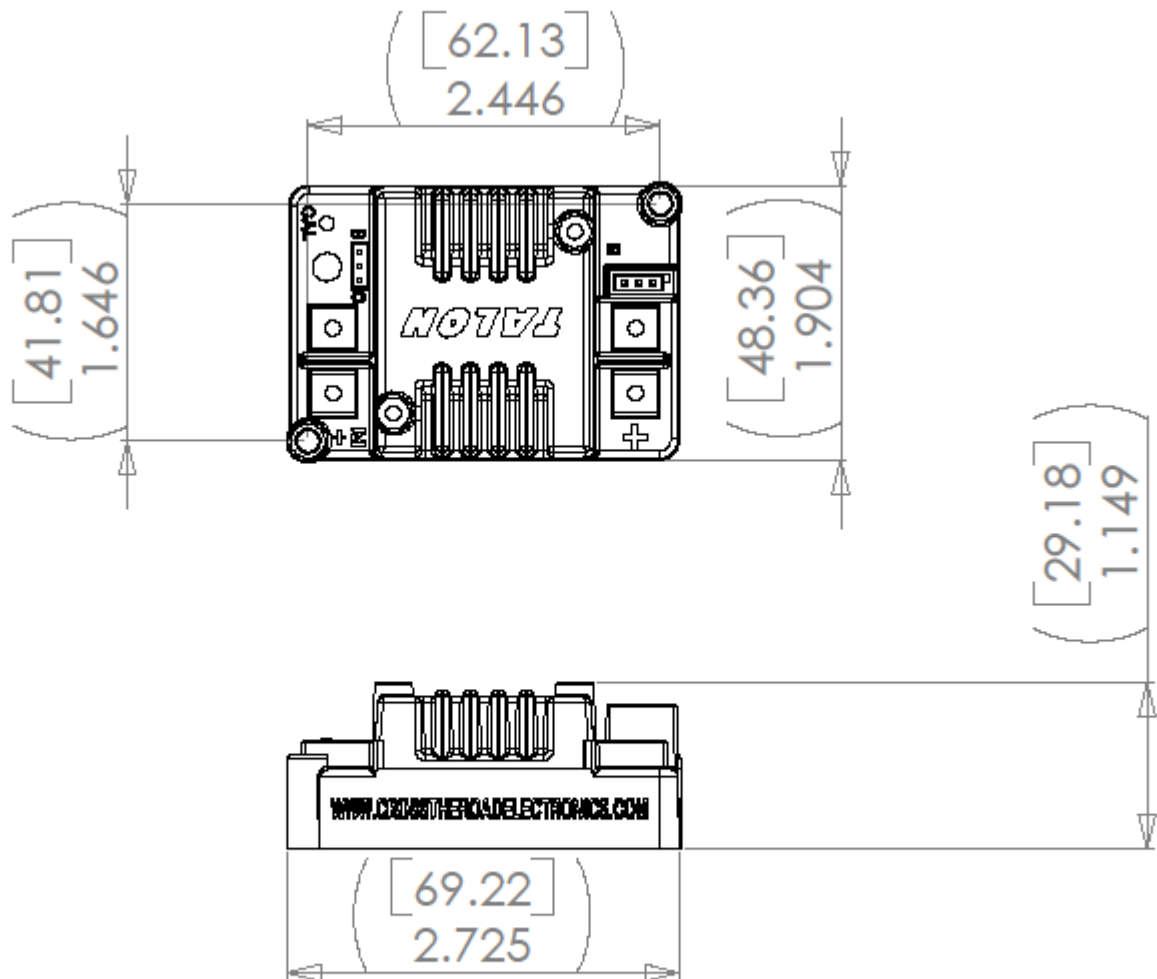

Figure 5

13) Electrical Specifications

Input voltage	6-28 VDC
Continuous current	60 A
Peak current	100 A
Input PWM signal	1-2 ms @ 333 Hz
Input resolution	10-bit (1024 steps)
Output resolution	10-bit (1024 steps)
Output switching frequency	15 kHz

14) Version History

Version 1.3 – Added Talon SR changes. Updated warning language on page 4.

Version 1.2: - Updated Input PWM signal refresh rate.

Version 1.1: -Added section on mounting.
-Renamed images to figures.
-Increased visibility of warnings.
-Updated expected PWM values.

Version 1.0: Initial releases no changes to note.